

INDICATORS • SPEAKERS • SOUND TRANSDUCERS • ENCLOSURES • MICROPHONES • BATTERY ACCESSORIES

CS15-00P70-02-1

Former P/N: CES150V025BA08PMN700UR

 Rev. 1-2019
 RoHS3 & REACH
 Mobile Speakers

Operating Characteristics

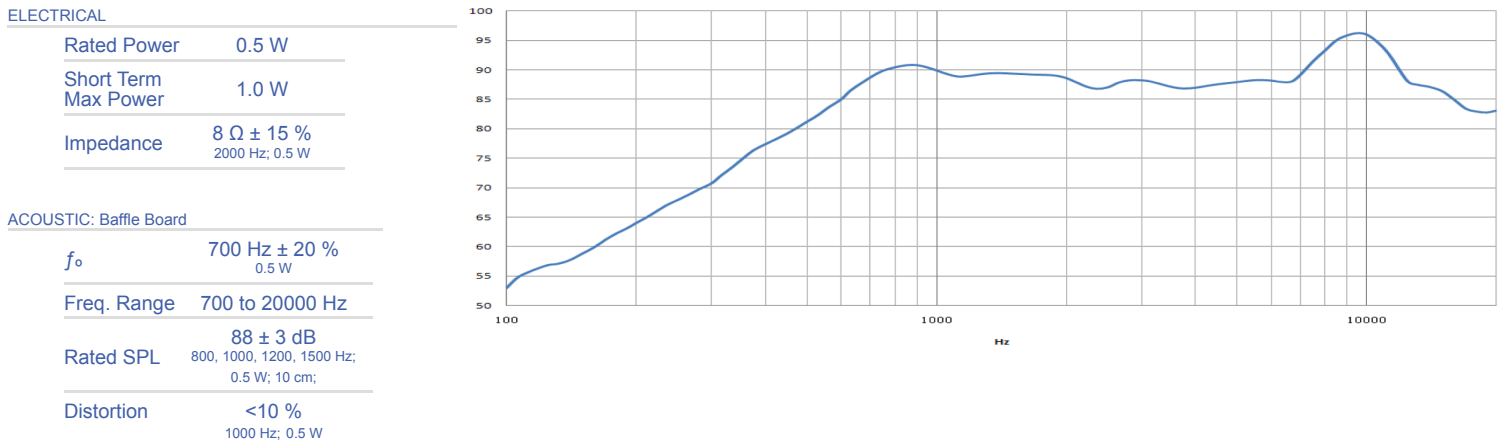

Physical Characteristics

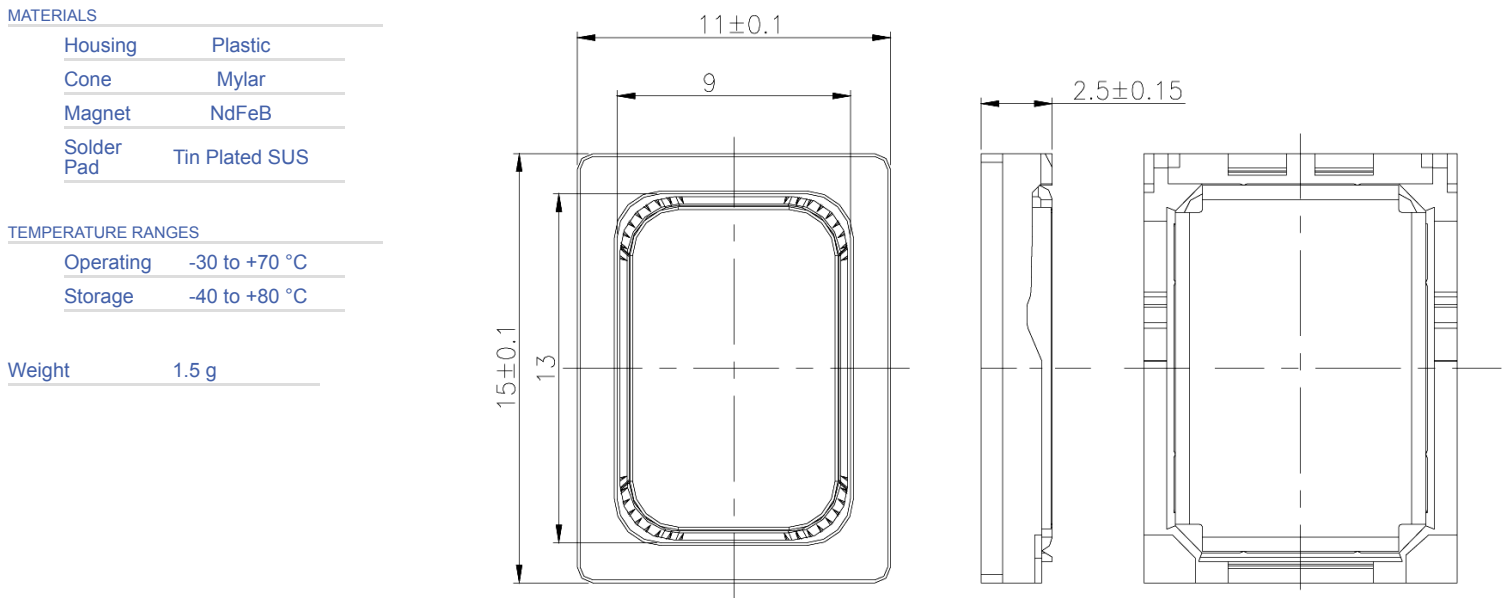

Revision	Description	By	Date
1-2019	Migrate to new format	JL	2019-06-21

Warranty: For a period of one (1) year from date of shipping under normal operations conditions This warranty does not apply to products damaged through misuse, abuse, improper installation, alteration, rework, or attempt to repair.