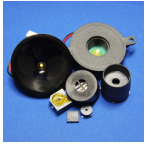

# CT08E-04S270-3

 Rev. 1-2021  
 RoHS3 & REACH  
 Electromagnetic Sound Transducers

## Operating Characteristics

### ELECTRICAL

Rated Voltage	3.6 Vo-p
Operating Voltage	2.5 to 4.5 Vo-p
Coil Resistance	16 ± 3 Ω
Coil Inductance*	Max 565 uH @ 25°C
Max Current at V Rated	90 mA

### ACOUSTIC

Min SPL at V Rated	92 dB
Test Conditions	10 cm
f <sub>o</sub>	2700 Hz

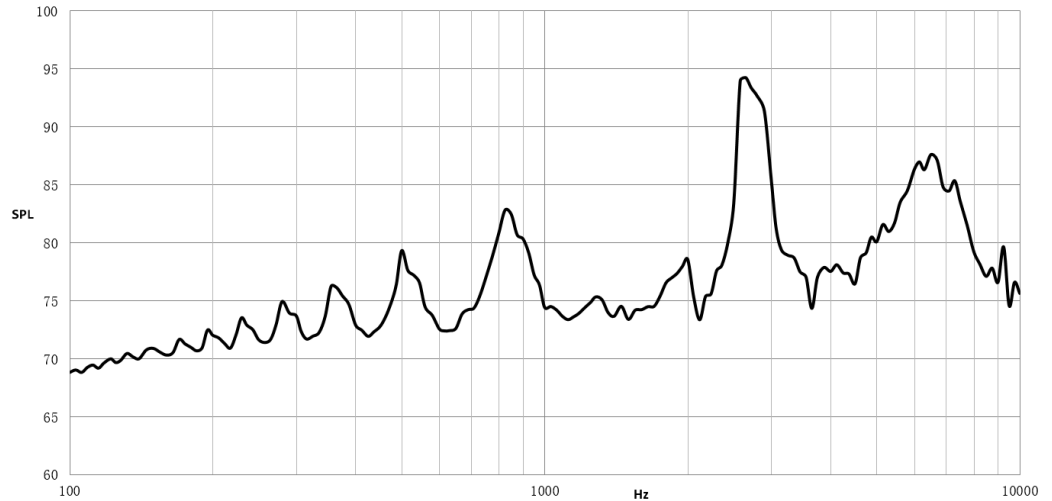

## Physical Characteristics

### MATERIAL

Housing	LCP
Diaphragm	Iron
Solder Pad	Brass

### TEMPERATURE RANGES

Operating	-40 to +85 °C
Storage	-40 to +85 °C

Weight	0.6 g
--------	-------

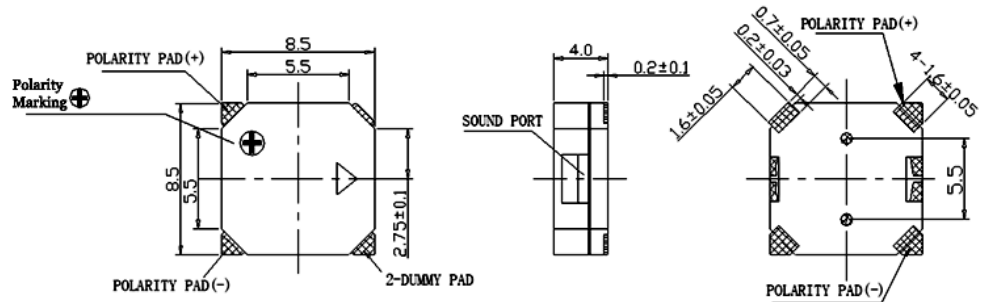

Unless otherwise specified, tolerance: ±0.5(unit:mm)

All Measurements are mm unless noted otherwise.

Revision	Description	By	Date
0-2020	Original Specification	WS	2020-12-10
1-2021	Added Coil Inductance, recommended footprint, recommended reflow profile, and tape and reel packaging.	JL	2021-11-24

Warranty: For a period of one (1) year from date of shipping under normal operations conditions. This warranty does not apply to products damaged through misuse, abuse, improper installation, alteration, rework, or attempt to repair.

\*Coil Inductance is guaranteed by design, not production tested.

The information contained herein is believed to be correct, but no guarantee or warranty, express or implied, with respect to accuracy, completeness or results is extended and no liability is assumed. Challenge Electronics reserves the right to make changes in any specification, data or material contained herein.

©2021 Challenge Electronics, Inc. Pub. 20211124102102

# CT08E-04S270-3

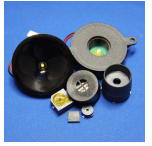
 Rev. 1-2021  
 RoHS3 & REACH  
 Electromagnetic Sound Transducers

## Recommended Footprint

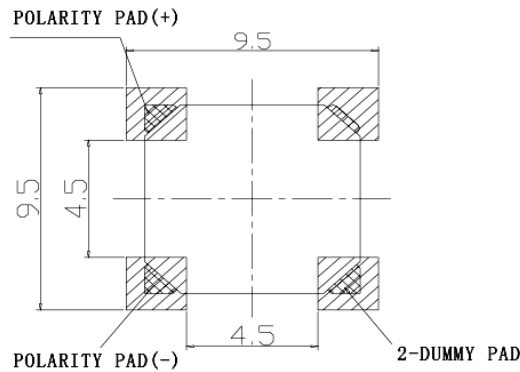

## Recommended Reflow Profile

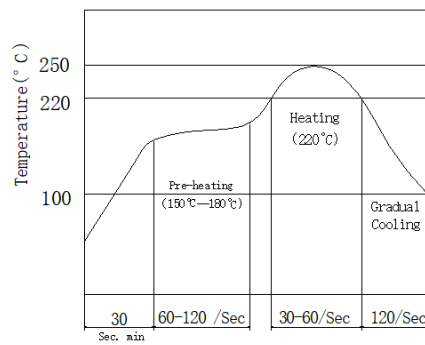

## Tape & Reel Packaging

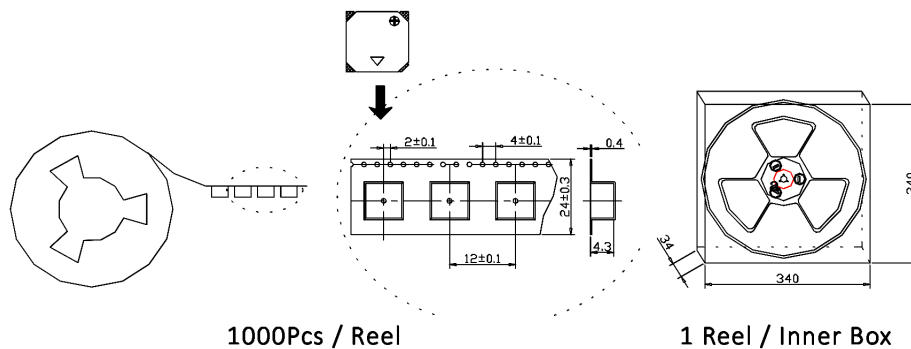

Revision	Description	By	Date
0-2020	Original Specification	WS	2020-12-10
1-2021	Added Coil Inductance, recommended footprint, recommended reflow profile, and tape and reel packaging.	JL	2021-11-24

**Warranty:** For a period of one (1) year from date of shipping under normal operations conditions. This warranty does not apply to products damaged through misuse, abuse, improper installation, alteration, rework, or attempt to repair.

\*Coil Inductance is guaranteed by design, not production tested.

The information contained herein is believed to be correct, but no guarantee or warranty, express or implied, with respect to accuracy, completeness or results is extended and no liability is assumed. Challenge Electronics reserves the right to make changes in any specification, data or material contained herein.

©2021 Challenge Electronics, Inc. Pub. 20211124110509