

INDICATORS • SPEAKERS • SOUND TRANSDUCERS • ENCLOSURES • MICROPHONES • BATTERY ACCESSORIES

## CT27Z-30N230-1

Former P/N: CEPX2300-270-02C30-500R

 Rev. 1-2019  
 RoHS3 & REACH  
 Piezo Element Sound Transducers

### Operating Characteristics

#### ELECTRICAL

Max Operating Voltage	30 Vp-p
Max Resonant Impedance	500 Ω
Capacitance	45000 pF ± 30 % 100 Hz

#### ACOUSTIC: Free Air

$f_o$	2300 ± 500 Hz
-------	---------------

### Physical Characteristics

#### MATERIAL

Diaphragm	Brass
-----------	-------

#### TEMPERATURE RANGES

Operating	-20 to +70 °C
Storage	-30 to +80 °C

Weight	0.7 g
--------	-------

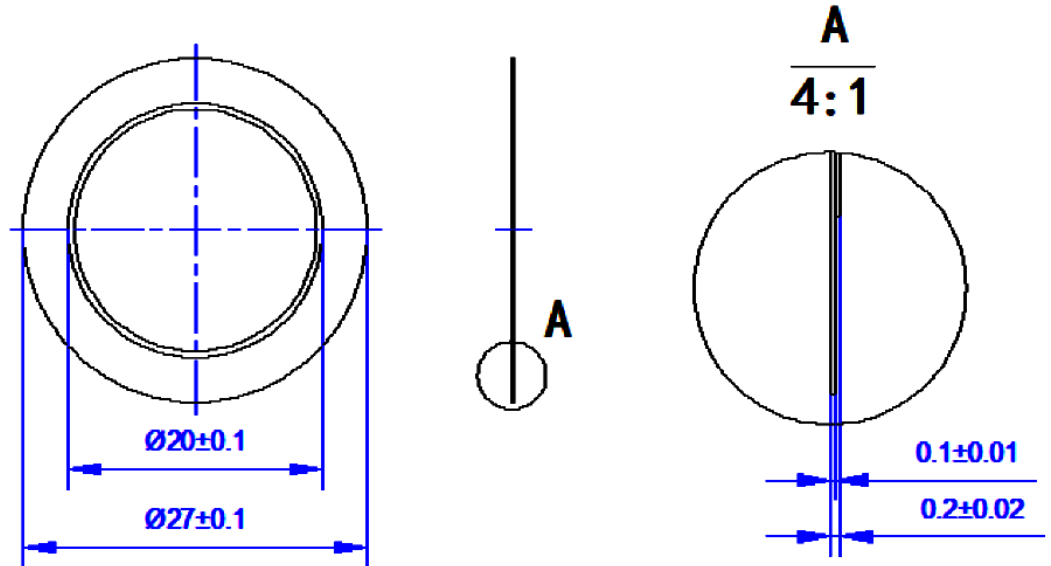

Revision	Description	By	Date
1-2019	Migrate to new format	JL	2019-06-21

Warranty: For a period of one (1) year from date of shipping under normal operations conditions This warranty does not apply to products damaged through misuse, abuse, improper installation, alteration, rework, or attempt to repair.

The information contained herein is believed to be correct, but no guarantee or warranty, express or implied, with respect to accuracy, completeness or results is extended and no liability is assumed. Challenge Electronics reserves the right to make changes in any specification, data or material contained herein.  
 ©2019 Challenge Electronics, Inc. 20190826155548