

CM04M-03S26-MD-3

Rev. 0-2022
RoHS3 & REACH
Omni Directional Microphones



Operating Characteristics

ELECTRICAL

Type	Digital
Rated Voltage	1.8 VDC
Operating Voltage	1.6 to 3.6 VDC
Max Short Circuit Current	10 mA
Capacitance	N/A

ACOUSTIC - Sleep Mode @ 94dB; 1000 Hz; Rated Voltage

Clock Frequency Range	-
Sleep Current	5 uA
*Tested At 100mVpp square wave @217Hz, A-weighted	
**Tested At 100mVpp square wave @217Hz, A-weighted	

ACOUSTIC - General

Technology	MEMS
Directionality	Omni Directional

ACOUSTIC-Standard Mode @ 94dB;1000 Hz;Rated Voltage;CLK Freq.-2.048 MHz

Clock Frequency Range	1.024 - 3.072 MHz
Supply Current	850 uA
Sensitivity	-26 ± 1 dBFS
Signal-to-Noise	64 dB(A)
Power Supply Rejection*	-85 dBFS
PSR Ratio**	59 dBV/FS
Acoustic Overload Point	120 dB SPL
Total Harmonic Distortion	1 % Max

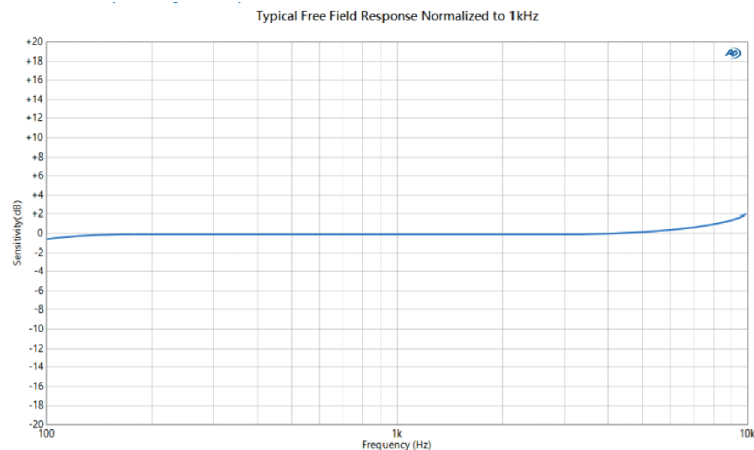

Revision	Description	By	Date
0-2022	Original Specification	AL	2022-07-07

Warranty: For a period of one (1) year from date of shipping under normal operations conditions. This warranty does not apply to products damaged through misuse, abuse, improper installation, alteration, rework, or attempt to repair.

The information contained herein is believed to be correct, but no guarantee or warranty, express or implied, with respect to accuracy, completeness or results is extended and no liability is assumed. Challenge Electronics reserves the right to make changes in any specification, data or material contained herein.

CM04M-03S26-MD-3

 Rev. 0-2022
 RoHS3 & REACH
 Omni Directional Microphones

Operating Characteristics

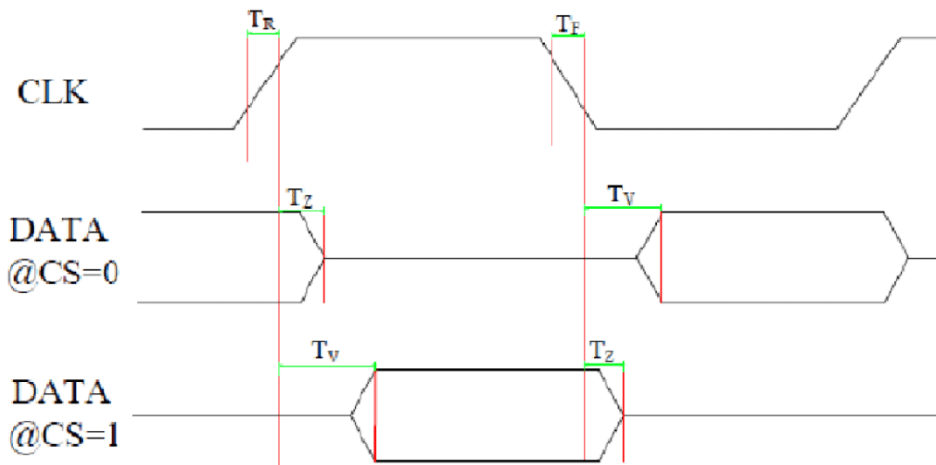

Timing Characteristics

Parameter	Symbol	Min	Typ	Max	Unit	Comments
Clock Rising Time	TR			10	ns	RL=1MΩ, CL=12pF
Clock Falling Time	TF			10	ns	RL=1MΩ, CL=12pF
DATA into Hi Z Time	TZ	0		15	ns	RL=1MΩ, CL=12pF
DATA Valid Time	TV	18		40	ns	RL=1MΩ, CL=12pF
Clock Jitter				0.5	ns	Period jitter in RMS
Clock Duty Cycle		40	50	60	%	
Clock Frequency		1.024	2.048	3.072	MHZ	

Parameter	Symbol	Condition	Min	Typ.	Max	Unit
Logic Input High	Vih		0.75x VDD	-	-	V
Logic Input Low	Vil		-	-	0.25x VDD	V
Logic Output High	Voh		VDDx 0.9	-	-	V
Logic Output Low	Vol		-	-	0.1x VDD	V

Revision	Description	By	Date
0-2022	Original Specification	AL	2022-07-07

Warranty: For a period of one (1) year from date of shipping under normal operations conditions. This warranty does not apply to products damaged through misuse, abuse, improper installation, alteration, rework, or attempt to repair.

The information contained herein is believed to be correct, but no guarantee or warranty, express or implied, with respect to accuracy, completeness or results is extended and no liability is assumed. Challenge Electronics reserves the right to make changes in any specification, data or material contained herein.

CM04M-03S26-MD-3

Rev. 0-2022
RoHS3 & REACH
Omni Directional Microphones

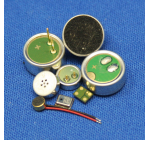

Physical Characteristics

MATERIAL

Solder Pads Gold Plated Copper

TEMPERATURE RANGES

Operating -40 to +85 °C

Storage -40 to +105 °C

Weight 0.033 g

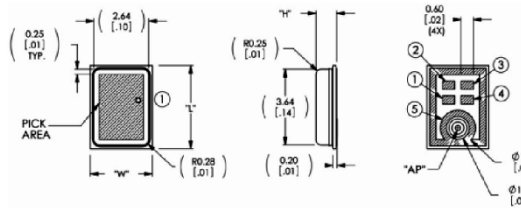

Item	Dimension	Tolerance
Length(L)	4.00	±0.10
Width(W)	3.00	±0.10
Height(H)	1.00	±0.10
Acoustic Port (AP)	Ø0.25	±0.10

Pin #	Pin Name	Description
1	VDD	Power Supply
2	DATA	PDM Output
3	CLOCK	Clock Input
4	CS	Lo/Hi (L/R) Select This pin is internally pulled low . but should not be left floating.
5	GND	GND

General tolerance = ±0.1 mm and all measurements in mm unless otherwise noted.

Interface Circuit

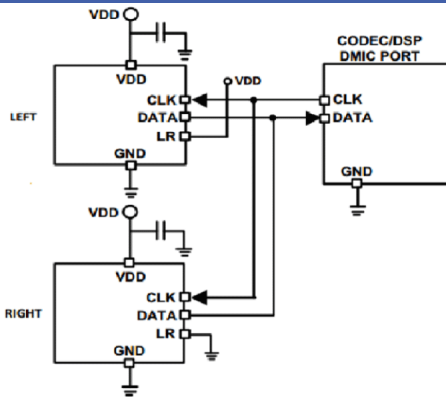

Microphone	SELECT	Asserts DATA On	Latch DATA On
Mic (High)	V _{DD}	Rising Clock Edge	Falling Clock Edge
Mic (Low)	GND	Falling Clock Edge	Rising Clock Edge

Note:

All GND pins must be connected to ground.

Capacitors near the microphone should not contain Class 2 dielectrics.

Revision	Description	By	Date
0-2022	Original Specification	AL	2022-07-07

Warranty: For a period of one (1) year from date of shipping under normal operations conditions. This warranty does not apply to products damaged through misuse, abuse, improper installation, alteration, rework, or attempt to repair.

The information contained herein is believed to be correct, but no guarantee or warranty, express or implied, with respect to accuracy, completeness or results is extended and no liability is assumed. Challenge Electronics reserves the right to make changes in any specification, data or material contained herein.

CM04M-03S26-MD-3

 Rev. 0-2022
 RoHS3 & REACH
 Omni Directional Microphones

Recommended Footprint

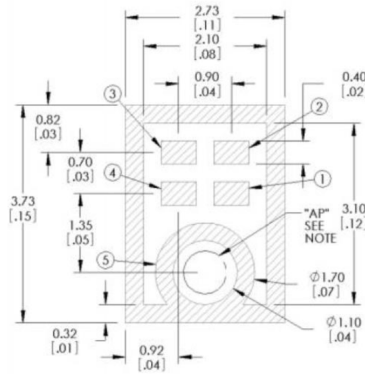

Recommended Reflow Profile

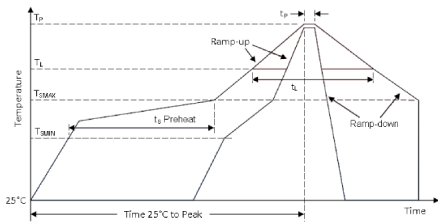

Profile Feature		Lead(Pb) Free Solder
Preheat	Temperature min.(T _{Smin})	150°C
	Temperature max.(T _{Smax})	200°C
	Time (t ₂₅)	60-180 Seconds
Liquidous	Temperature (T _L)	217°C
	Time (t _L)	60-150 Seconds
Peak	Temperature (T _P)	260°C
	Time within 5°C of actual peak temperature (t _P)	20-40 Seconds
Ramp up	Average ramp up rate T _{Smax} to T _P	3°C / Second Max.
Ramp down	Average ramp down rate T _P to T _{Smax}	6°C / Second Max.
Time 25°C to Peak temperature		8 Minutes Max.

Note:

All temperatures refer to topside of the package, measured on the package body surface.

Tape & Reel Packaging

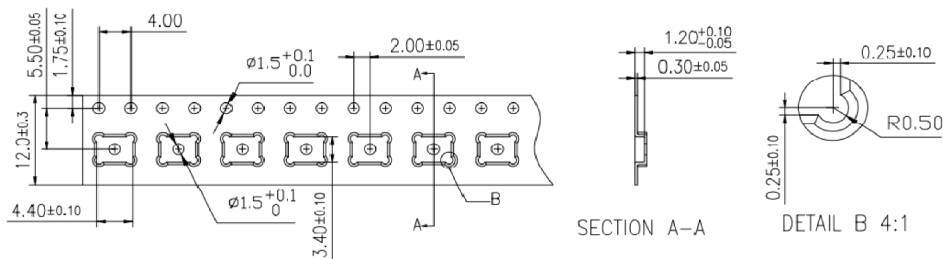

Reel Diameter	Quantity Per Reel
13"	5,000

Revision	Description	By	Date
0-2022	Original Specification	AL	2022-07-07

Warranty: For a period of one (1) year from date of shipping under normal operations conditions. This warranty does not apply to products damaged through misuse, abuse, improper installation, alteration, rework, or attempt to repair.

The information contained herein is believed to be correct, but no guarantee or warranty, express or implied, with respect to accuracy, completeness or results is extended and no liability is assumed. Challenge Electronics reserves the right to make changes in any specification, data or material contained herein.